

# KAZE | RGB Streaming Microphone



USER MANUAL

# MAIN FEATURES

EN

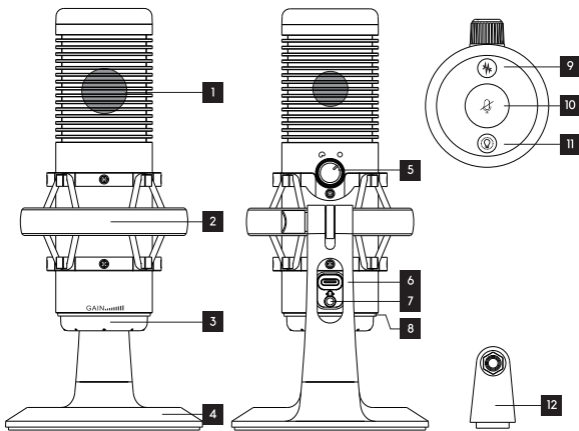

1	Condenser mic	5	Polar pattern knob	9	Noise cancelling
2	Anti-Shock mount	6	USB Type-C port	10	Mute button
3	Volume knob	7	3.5 mm jack port	11	LED control button
4	Stand base	8	LED indicator	12	3/8" - 5/8" adapter

## ASSEMBLY

- 1 You can adjust the angle of the microphone in the stand as you need.

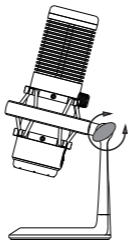

- 2 You can mount the microphone into a boom arm stand with the 3/8" - 5/8" adapter included.

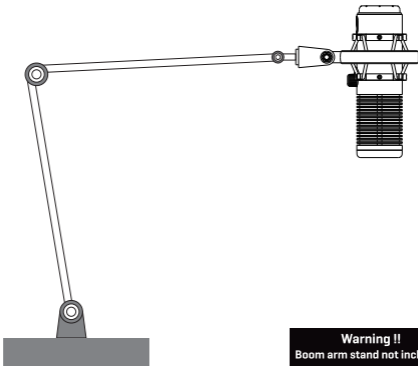



**Warning !!**  
Boom arm stand not included

## CONNECTION

1. Plug the microphone USB into an empty computer USB port .
2. Wait until the PC detects and configures the microphone.
3. For more info or help, please visit our website:  
[www.kromgaming.com](http://www.kromgaming.com)

## MAIN FUNCTIONS



### POLAR PATTERN

-  **Cardioid mode:** suitable for individual calls, gaming, streaming, ASMR, vlogging, etc.
-  **Omnidirectional mode:** suitable for group calls, music recording, group streaming, etc.

### VOLUME CONTROL

Turn the volume knob to adjust the volume of recording as you need.

### TOUCH SWITCH

-  **Mute:** Touch the key quickly to mute. LED indicator ring will change to red and other light will be turned off at the same time.
-  **Noise suppress:** Touch the key one time, low environmental noise will be canceled, the LED indicator ring will blink, touch the key again, enter to default sound mode.
-  **Light switch:** Touch the LED key to switch between different lighting mode.

### MONITORING

Ensure this product is selected as playback device in your computer audio settings.

Plug a 3.5mm jack headphone into the 3.5mm jack port.  
Adjust the monitoring volume through the computer.

## MONTAJE

- 1 Puedes ajustar el ángulo del micrófono en el soporte según necesites.

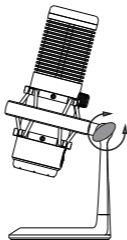

- 2 Puede montar el micrófono en un soporte de brazo articulado con el adaptador de 3/8" - 5/8" incluido.

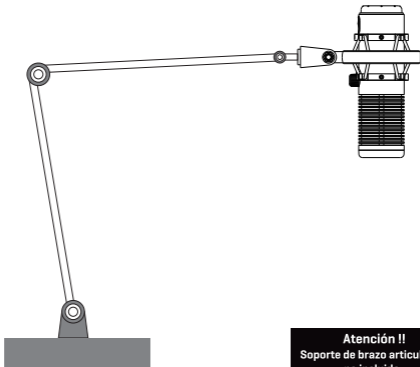



**Atención !!**  
Soporte de brazo articulado  
no incluido

## CONEXIÓN

1. Conecte el micrófono USB a un puerto USB vacío del ordenador.
2. Espere hasta que el ordenador lo detecte y configure el micrófono.
3. Para obtener más información o ayuda, visite nuestro sitio web: [www.kromgaming.com](http://www.kromgaming.com)

## FUNCIONES PRINCIPALES



### PATRÓN POLAR

-  **Modo cardioide:** adecuado para llamadas individuales, juegos, streaming, ASMR, vlogs, etc.
-  **Modo omnidireccional:** adecuado para llamadas grupales, grabación de música, transmisión grupal, etc.

### CONTROL DEL VOLUMEN

Gire la perilla de volumen para ajustar el volumen de grabación según necesite.

### INTERRUPTOR TACTIL

-  **Silenciar:** toque la tecla rápidamente para silenciar. El anillo indicador LED cambiará a la luz roja y otras se apagarán al mismo tiempo.
-  **Supresión de ruido:** toque la tecla una vez y se activará un nivel de ruido ambiental bajo, el anillo indicador LED parpadeará, toque la tecla nuevamente para volver al modo de sonido predeterminado.
-  **Interruptor de luz:** toque la tecla LED para cambiar entre diferentes modos.

### SUPERVISIÓN

Asegúrese de que este producto esté seleccionado como dispositivo de reproducción en la configuración de audio de su ordenador. Conecte unos auriculares con conector de 3,5 mm al puerto jack de 3,5 mm. Ajuste el volumen de monitoreo a través de su ordenador.

## ASSEMBLÉ

- 1 Vous pouvez ajuster l'angle du microphone dans le support selon vos besoins.

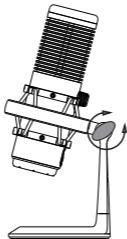

- 2 Vous pouvez monter le microphone sur un support à perche avec l'adaptateur 3/8" - 5/8" inclus.

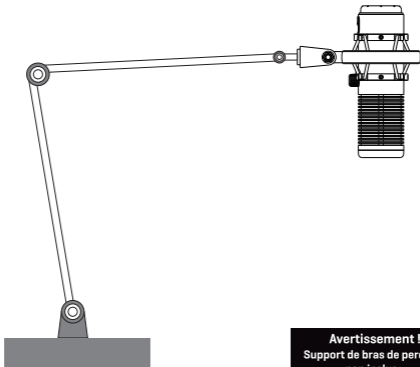



**Avertissement !!**  
Support de bras de perche  
non inclus

## CONNEXION

1. Branchez le microphone USB sur un port USB vide de l'ordinateur.
2. Attendez que le PC détecte et configure le microphone.
3. Pour plus d'informations ou d'aide, veuillez visiter notre site Web : [www.kromgaming.com](http://www.kromgaming.com)

## FONCTIONS PRINCIPALES



### MOTIF POLAIRE

-  **Mode Cardiod** : adapté aux appels individuels, aux jeux, au streaming, à l'ASMR, vlogging, etc.
-  **Mode omnidirectionnel** : adapté aux appels de groupe, à l'enregistrement de musique, diffusion en groupe, etc.

### CONTRÔLE DU VOLUME

Tournez le bouton de volume pour régler le volume de l'enregistrement selon vos besoins.

### INTERRUPTEUR TACTILE

-  **Muet** : appuyez rapidement sur la touche pour mettre en sourdine. L'anneau indicateur LED deviendra le rouge et les autres lumières seront éteints en même temps.
-  **Suppression du bruit** : appuyez une fois sur la touche, un faible bruit ambiant sera être annulé, l'anneau indicateur LED clignote, appuyez à nouveau sur la touche, entrez dans le mode sonore par défaut.
-  **Interrupteur d'éclairage** : appuyez sur la touche LED pour basculer entre différents éclairages mode.

### SURVEILLANCE

Assurez-vous que ce produit est sélectionné comme périphérique de lecture dans les paramètres audio de votre ordinateur.  
Branchez un casque jack 3,5 mm dans le port jack 3,5 mm.  
Réglez le volume de surveillance via l'ordinateur.



## MONTAGEM

- 1 Você pode ajustar o ângulo do microfone no suporte conforme necessário.

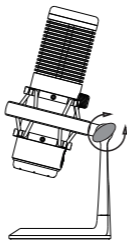

- 2 Você pode montar o microfone em um suporte de braço boom com o adaptador de 3/8" - 5/8" incluído.

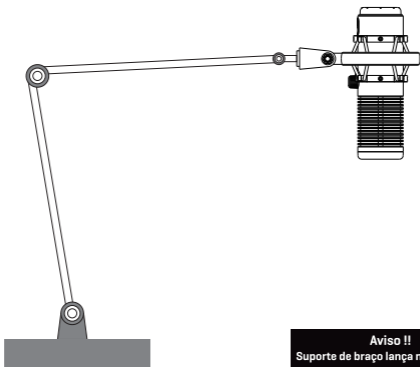



**Aviso !!**  
Suporte de braço lança não incluído

## CONNECTION

1. Conecte o microfone USB em uma porta USB vazia do computador.
2. Aguarde até que o PC detecte e configure o microfone.
3. Para mais informações ou ajuda, visite nosso site:  
[www.kromgaming.com](http://www.kromgaming.com)

## MAIN FUNCTIONS



### PADRÃO POLAR

-  **Modo cardioid:** adequado para chamadas individuais, jogos, streaming, ASMR, vlogging, etc.
-  **Modo omnidirecional:** adequado para chamadas em grupo, streaming de grupo de gravação de música, etc.

### CONTROLE DE VOLUME

Gire o botão de volume para ajustar o volume da gravação conforme necessário.

### INTERRUPTOR DE TOQUE

-  **Mudo:** Toque na tecla rapidamente para silenciar. O anel indicador LED mudará para vermelho e outras luzes serão apagadas ao mesmo tempo.
-  **Supressão de ruído:** Toque na tecla uma vez, o baixo ruído ambiental será cancelado, o anel indicador LED piscará, toque na tecla novamente, entre no modo de som padrão.
-  **Interruptor de luz:** Toque na tecla LED para alternar entre os diferentes modos de iluminação.

### MONITORAMENTO

Certifique-se de que este produto esteja selecionado como dispositivo de reprodução nas configurações de áudio do seu computador. Conecte um fone de ouvido de 3,5 mm na porta de 3,5 mm. Ajuste o volume de monitoramento através do computador.

## MONTAGGIO

- 1 Puoi regolare l'angolazione del microfono nel supporto secondo le tue necessità.

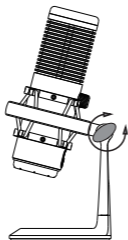

- 2 È possibile montare il microfono su un supporto a braccio con l'adattatore da 3/8" - 5/8" incluso.

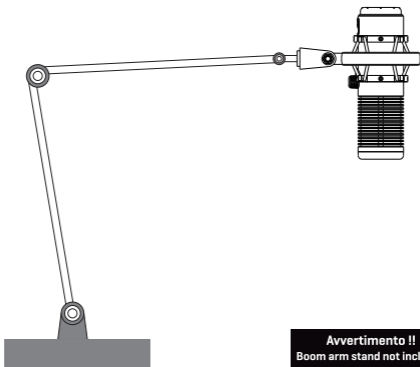



**Avvertimento !!**  
Boom arm stand not included

## CONNESSIONE

1. Collegare il microfono USB a una porta USB vuota del computer.
2. Attendere finché il PC non rileva e configura il microfono.
3. Per ulteriori informazioni o aiuto, visitare il nostro sito Web:  
[www.kromgaming.com](http://www.kromgaming.com)

## FUNZIONI PRINCIPALI



### MODELLO POLARE

-  **Modalità cardioide:** adatta per chiamate individuali, giochi, streaming, ASMR, vlogging, ecc.
-  **Modalità omnidirezionale:** adatta per chiamate di gruppo, registrazione musicale, streaming di gruppo, ecc.

### CONTROLLO DEL VOLUME

Ruota la manopola del volume per regolare il volume della registrazione in base alle tue esigenze.

### INTERRUTTORE TOUCH

-  **Muto:** toccare rapidamente il tasto per disattivare l'audio. L'anello indicatore LED diventerà rosso e le altre luci si spegneranno contemporaneamente.
-  **Soppressione del rumore:** toccare il tasto una volta, il basso rumore ambientale verrà annullato, l'anello indicatore LED lampeggerà, toccare nuovamente il tasto ed accedere alla modalità audio predefinita.
-  **Interruttore della luce:** toccare il tasto LED per passare da una modalità di illuminazione all'altra.

### MONITORAGGIO

Assicurati che questo prodotto sia selezionato come dispositivo di riproduzione nelle impostazioni audio del tuo computer. Collega una cuffia con jack da 3,5 mm alla porta jack da 3,5 mm. Regolare il volume di monitoraggio tramite il computer.

## MONTAGE

DE

- 1 Sie können den Winkel des Mikrofons im Ständer nach Bedarf anpassen.

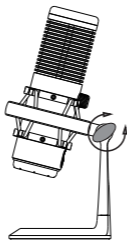

- 2 Sie können das Mikrofon mit dem mitgelieferten 3/8-Zoll-  
II-5/8-Zoll-Adapter an einem Galgenarmstativ montieren.

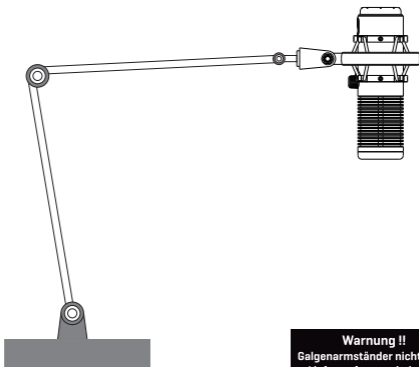



**Warnung !!**  
Galgenarmständer nicht im  
Lieferumfang enthalten

## VERBINDUNG

1. Stecken Sie den USB-Anschluss des Mikrofons in einen leeren USB-Anschluss des Computers.
2. Warten Sie, bis der PC das Mikrofon erkennt und konfiguriert.
3. Für weitere Informationen oder Hilfe besuchen Sie bitte unsere Website: [www.kromgaming.com](http://www.kromgaming.com)

## HAUPTFUNKTIONEN



### POLARES MUSTER

-  **Cardiod-Modus:** geeignet für Einzelgespräche, Gaming, Streaming, ASMR, Vlogging usw.
-  **Omnidirektionaler Modus:** geeignet für Gruppenanrufe, Musikaufnahmen, Gruppen-Streaming usw.

### LAUTSTÄRKEREGELUNG

Drehen Sie den Lautstärkeregler, um die Aufnahmelautstärke nach Bedarf anzupassen.

### BERÜHRUNGSSCHALTER

-  **Stummschaltung:** Berühren Sie die Taste schnell, um die Stummschaltung zu aktivieren. Der LED-Anzeigering wechselt zu Rot und andere Lichter werden gleichzeitig ausgeschaltet.
-  **Geräuschunterdrückung:** Berühren Sie die Taste einmal, geringe Umgebungsgeräusche werden ausgeschaltet, der LED-Anzeigering blinkt, berühren Sie die Taste erneut, um zum Standard-Soundmodus zu gelangen.
-  **Lichtschalter:** Berühren Sie die LED-Taste, um zwischen verschiedenen Beleuchtungsmodi zu wechseln.

### ÜBERWACHUNG

Stellen Sie sicher, dass dieses Produkt in den Audioeinstellungen Ihres Computers als Wiedergabegerät ausgewählt ist.

Stecken Sie einen 3,5-mm-Klinkenkopfhörer in den 3,5-mm-Klinkenanschluss.

Passen Sie die Überwachungslautstärke über den Computer an.