

USER MANUAL



UNINTERRUPTIBLE POWER SUPPLY SYSTEMS (UPS)

SPS ADVANCE R & T

0,75.. 1,5 kVA & 0,85.. 3 kVA

SALICRU

General index.

1. INTRODUCTION.

- 1.1. THANK YOU LETTER.

2. SAFETY INFORMATION.

- 2.1. USING THIS MANUAL.
 - 2.1.1. Conventions and symbols used.

3. QUALITY ASSURANCE AND STANDARDS.

- 3.1. STATEMENT BY THE MANAGEMENT.
- 3.2. STANDARDS.
- 3.3. ENVIRONMENT.

4. PRESENTATION.

- 4.1. VIEWS.
 - 4.1.1. Views of the device.
 - 4.1.1.1. Views of the SPS ADVANCE R device.
 - 4.1.1.2. Views of the SPS ADVANCE T device.
 - 4.2. DEFINITION OF THE PRODUCT.
 - 4.2.1. Nomenclature.
 - 4.3. OPERATING PRINCIPLE.
 - 4.3.1. Operating diagram
 - 4.3.2. Notable features.
 - 4.4. OPTIONAL EXTRAS.
 - 4.4.1. Isolation transformer:
 - 4.4.2. Communication card.
 - 4.4.2.1. Integration into computer networks using an SNMP adapter.
 - 4.4.3. Extendable guide kits for mounting in a rack cabinet (only in SPS ADVANCE R models).

5. INSTALLATION.

- 5.1. RECEPTION OF THE DEVICE.
 - 5.1.1. Reception, unpacking and contents.
 - 5.1.2. Storage.
 - 5.1.3. Transport to the site.
 - 5.1.4. Siting, immobilising and considerations.
 - 5.1.4.1. Rack-type mounting in a 19" cabinet (SPS ADVANCE R devices).
 - 5.1.4.2. Preliminary considerations before connection.
 - 5.1.4.3. Preliminary considerations before connection, regarding the batteries and their protections.
- 5.2. CONNECTIONS.
 - 5.2.1. Connection of the input.
 - 5.2.2. Connection of the IEC output connectors.

- 5.2.3. Output terminals (only in SPS ADVANCE T 3 KVA models).
- 5.2.4. Connection to the optional battery module (backup extension).
- 5.2.5. Terminals for EPO (emergency power off).
- 5.2.6. Communication port.
 - 5.2.6.1. RS232 and USB port.
- 5.2.7. Smart slot for the integration of an electronic communication unit (SNMP).
- 5.2.8. Management and monitoring software.
- 5.2.9. Considerations before start-up with connected loads.

6. OPERATION.

- 6.1. STARTUP.
 - 6.1.1. Checks before start-up.
- 6.2. UPS START-UP AND SHUTDOWN.
 - 6.2.1. UPS start-up with mains voltage.
 - 6.2.2. UPS start-up without mains voltage.
 - 6.2.3. UPS shutdown with mains voltage.
 - 6.2.4. UPS shutdown without mains voltage.

7. CONTROL PANEL WITH LCD DISPLAY.

- 7.1. COMPOSITION OF THE CONTROL PANEL WITH LCD DISPLAY.
- 7.2. GENERAL INFORMATION.
 - 7.2.1. Information represented by the display.
- 7.3. AUDIBLE ALARMS.
- 7.4. WARNING AND ERROR OR FAULT CODES.

8. MAINTENANCE, WARRANTY AND SERVICE.

- 8.1. BATTERY MAINTENANCE.
 - 8.1.1. Notes for the installation and replacement of the battery.
- 8.2. UPS TROUBLESHOOTING GUIDE.
- 8.3. WARRANTY CONDITIONS.
 - 8.3.1. Terms of the warranty.
 - 8.3.2. Exclusions.
- 8.4. TECHNICAL SERVICES NETWORK.

9. ANNEXES.

- 9.1. GENERAL TECHNICAL SPECIFICATIONS.
- 9.2. GLOSSARY.

1. INTRODUCTION.

1.1. THANK YOU LETTER.

We thank you in advance for the trust placed in us in the purchasing of this product. Read this instruction manual carefully in order to familiarize yourself with its content, since the more you know and understand the equipment the greater your satisfaction, level of safety and optimization of its functionalities will be. We remain at your disposal for any additional information or queries that you may wish to make.

Yours sincerely.

SALICRU

- The equipment described herein **is capable of causing significant physical damage in the event of improper handling**. For this reason its installation, maintenance and/or repair must be carried out exclusively by our personnel or by **qualified personnel**.
- Although no effort has been spared to ensure that the information in this user manual is complete and accurate, we are not responsible for any errors or omissions that may exist.
The images included in this document are for illustrative purposes and may not represent exactly the parts of the equipment shown, therefore they are not contractual. However, any divergence that may arise will be remedied or solved with the correct labelling on the unit.
- Following our policy of constant evolution, **we reserve the right to modify the characteristics, operations or actions described in this document without prior notice**.
- **Reproduction, copying, assignment to third parties, modification or total or partial translation** of this manual or document, in any form or by any means, **without previous written authorization by our firm is prohibited**, with the full and exclusive property rights over the same being reserved by our firm.

2. SAFETY INFORMATION.

2.1. USING THIS MANUAL.

The documentation of any standard equipment is available to the customer on our website for download (www.salicru.com).

- For devices “powered by socket”, this is the website for obtaining the user manual and **“Safety Instructions”** EK266*08.
- For devices with “permanent connection” via terminals, a CD-ROM or pen drive containing all necessary information for connection and start-up, including **“Safety Instructions”** EK266*08, may be supplied with it.

Before carrying out any action on the device relating to its installation or start-up, change of location, configuration or handling of any kind, carefully read the safety instructions.

The purpose of the user manual is to provide information regarding safety and explanations of the procedures for installation and operation of the equipment. Read them carefully and follow the steps indicated in the order established.



Compliance with the “Safety Instructions” is obligatory, with the user being legally responsible for observing and applying them.

The equipment is delivered properly labelled for the correct identification of each of the parts, which together with the instructions described in this user manual allows the operations of installation and commissioning to be performed in a simple and orderly manner without having any doubts whatsoever.

Finally, once the equipment is installed and operating, it is recommended to save the documentation downloaded from the website, CD-ROM or Pen Drive in a safe and easy-to-access place, for any future queries or doubts that may arise.

The following terms are used interchangeably in the document to refer to:

- **“SPS ADVANCE R, ADVANCE R, ADV R, R, R device, R unit or R UPS”** - Uninterruptible power supply.
Depending on the context of the phrase, it can refer either to the actual UPS itself or to the UPS and the batteries, regardless of whether it is all assembled in the same metal casing - box - or not.
- **“SPS ADVANCE T, ADVANCE T, ADV T, T, T device, T unit or T UPS”** - Uninterruptible power supply.
Depending on the context of the phrase, it can refer either to the actual UPS itself or to the UPS and the batteries, regardless of whether it is all assembled in the same metal casing - box - or not.
- **“Batteries or accumulators”**.- Group or set of elements that stores the flow of electrons by electrochemical means.
- **“T.S.S.”** - Technical Service and Support.
- **“Client, installer, operator or user”** - These are used interchangeably and by extension to refer to the installer and/or operator who will carry out the corresponding actions, and the same person may be responsible for carrying out the respective actions when acting on behalf of, or in representation of, same.

2.1.1. Conventions and symbols used.

Some symbols may be used and appear on the equipment, batteries and/or in the context of the user manual.

For more information, see section 1.1.1 of document EK266*08 on **“Safety instructions”**.

3. QUALITY ASSURANCE AND STANDARDS.

3.1. STATEMENT BY THE MANAGEMENT.

Our goal is customer satisfaction, therefore this Management has decided to establish a Quality and Environment Policy, through the implementation of a Quality and Environmental Management System that will enable us to comply with the requirements demanded in the **ISO 9001** and **ISO 14001** and also by our Customers and Stakeholders.

Likewise, the management of the company is committed to the development and improvement of the Quality and Environmental Management System, through:

- Communication to the entire company of the importance of satisfying both the client's requirements as well as legal and regulatory requirements.
- The dissemination of the Quality and Environment Policy and the setting of the Quality and Environment objectives.
- Conducting reviews by the Management.
- Providing the necessary resources.

3.2. STANDARDS.

The SPS ADVANCE R and SPS ADVANCE T are designed, manufactured and sold in accordance with Quality Management Standard **EN ISO 9001**. The **CE** marking indicates conformity with EC Directives through the application of the following standards:

- **2014/35/EU**. - Low voltage safety.
- **2014/30/EU**. - Electromagnetic Compatibility - EMC-.
- **2011/65/EU**. - Restriction of the use of hazardous substances in electrical and electronic equipment (RoHS).

According to the specifications of the harmonized standards. Reference standards:

- **EN-IEC 62040-1**. Uninterruptible Power Supplies -UPS-. Part 1-1: General and safety requirements for UPS used in user access areas.
- **EN-IEC 62040-2**. Uninterruptible Power Supplies -UPS-. Part 2: EMC requirements.



The manufacturer is not liable in case of modification or intervention on the equipment by the user.



WARNING!:

SPS.ADVANCE R 0.75..1.5 kVA and SPS.ADVANCE T 0.85..3 kVA. These are category C2 UPSs. In residential environments, this product may cause radio interference, in which case the user must take additional measures.

These devices should not be used with basic life support (BLS) applications, where a power failure can render the life support equipment out of service or significantly affect its safety or effectiveness. It is also not recommended in medical applications, commercial transport, nuclear installations, or other applications or loads, where a failure of the product can lead to personal or material damages.



The EC declaration of conformity of the product is available to the customer upon express request to our headquarters.

3.3. ENVIRONMENT.

This product has been designed to respect the environment and manufactured according to **ISO 14001**.

Recycling of the equipment at the end of its useful life:

Our company undertakes to use the services of authorized and regulatory companies to treat the set of products recovered at the end of their useful life (contact your distributor).

Packaging:

For the recycling of the packaging there must be compliance with the legal requirements in force, according to the specific regulations of the country where the equipment is installed.

Batteries:

Batteries pose a serious danger to health and the environment. The disposal of them shall be carried out in accordance with the laws in force.

4. PRESENTATION.

4.1. VIEWS.

4.1.1. Views of the device.

Fig. 1 and Fig. 2 correspond to SPS ADVANCE R devices and Fig. 3 and Fig. 4 to SPS ADVANCE T devices. However, because the product is constantly evolving, discrepancies or slight contradictions may arise. If in any doubt, the labelling on the equipment itself will always prevail.

i The nameplate of the device shows all of the values relating to its main properties and characteristics. Act accordingly for its installation.

4.1.1.1. Views of the SPS ADVANCE R device.

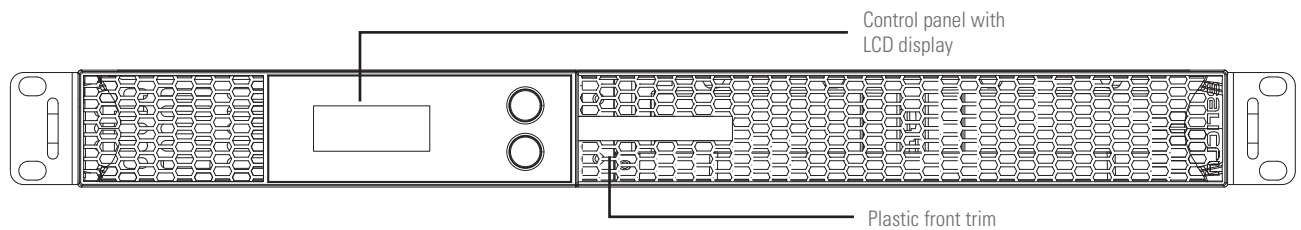

Fig. 1. Front view of the SPS ADVANCE R.

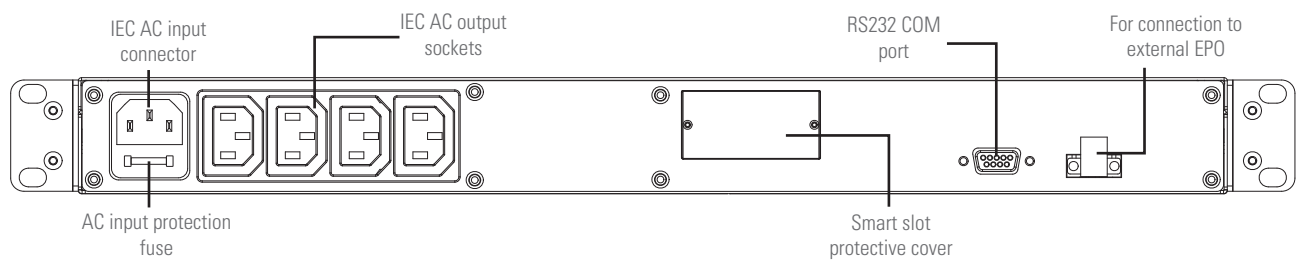
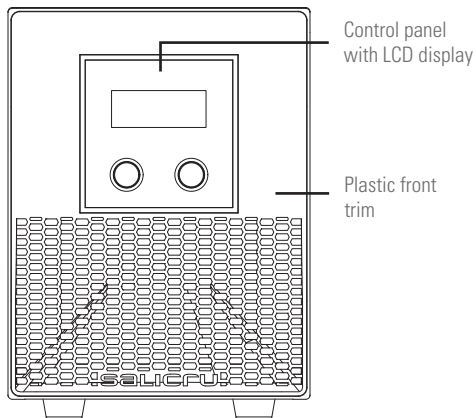

Fig. 2. Rear view of the SPS ADVANCE R.

4.1.1.2. Views of the SPS ADVANCE T device.

850 to 2000 VA models.

Batteries modules for 1000 to 2000 VA models.



Front view of the device.

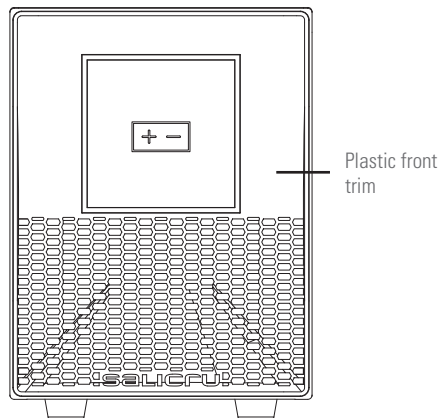

Front view of the batteries modules.

3000 VA models.

Battery module for 3000 VA model.

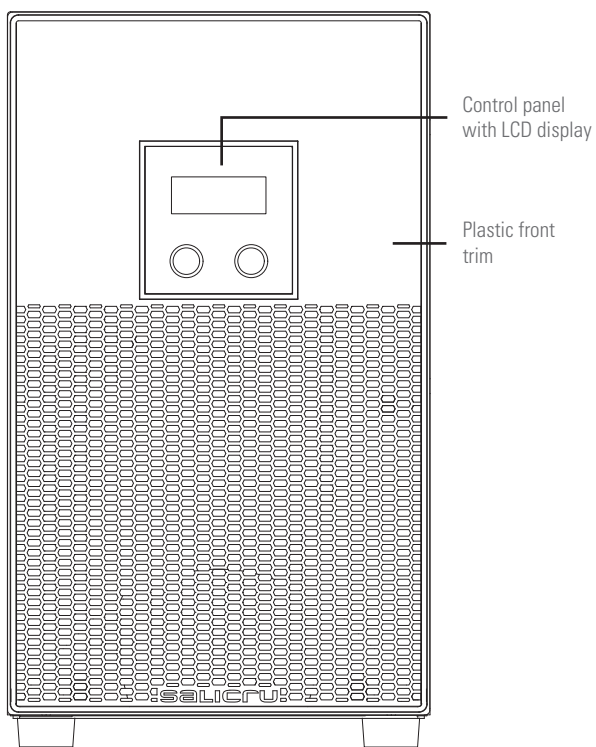

Front view of the device.

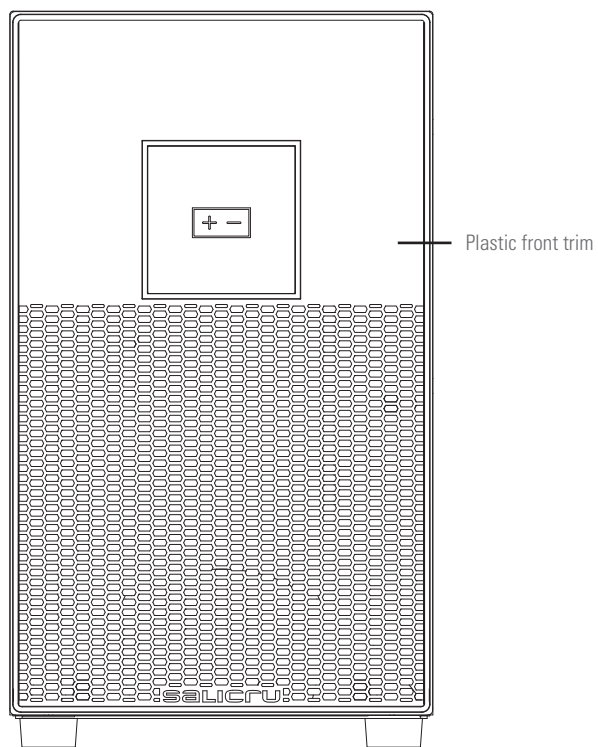

Front view of the battery module.

Fig. 3. Front view of SPS ADVANCE T devices according to power and battery modules.

850 to 2000 VA models.

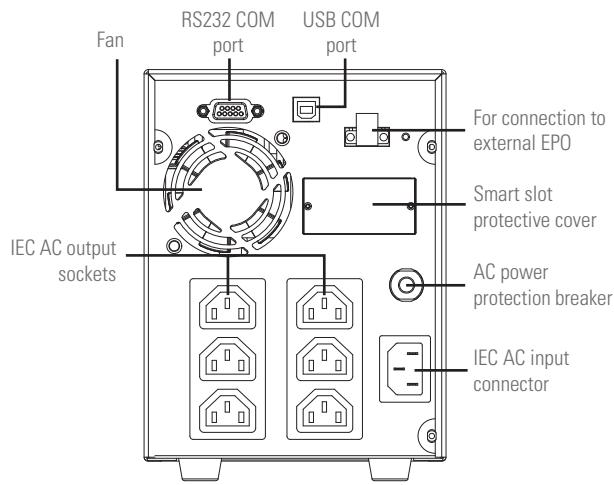

Rear view of the standard device.

1000 to 2000 VA B1 models.

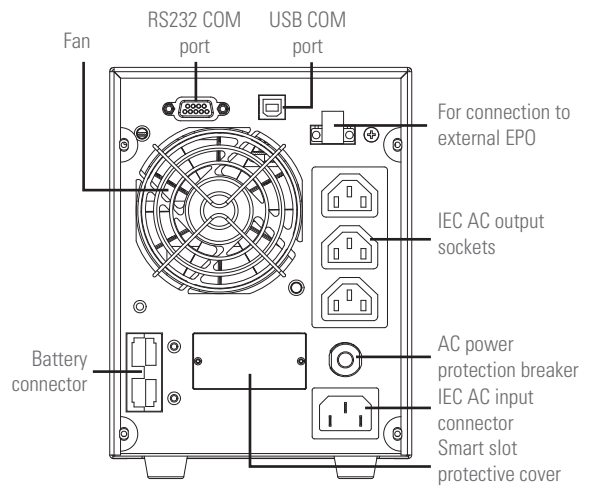

Rear view of the B1 device.

3000 VA model.

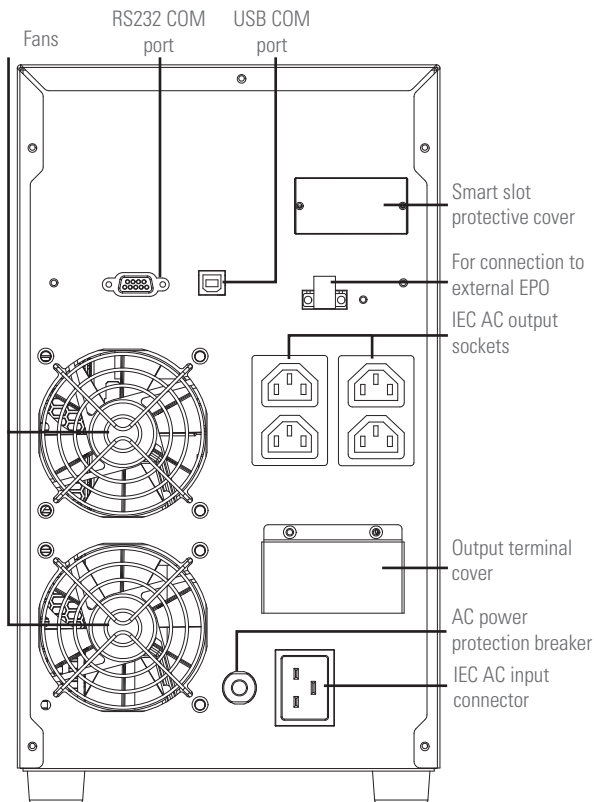

Rear view of the standard device.

3000 VA B1 model.

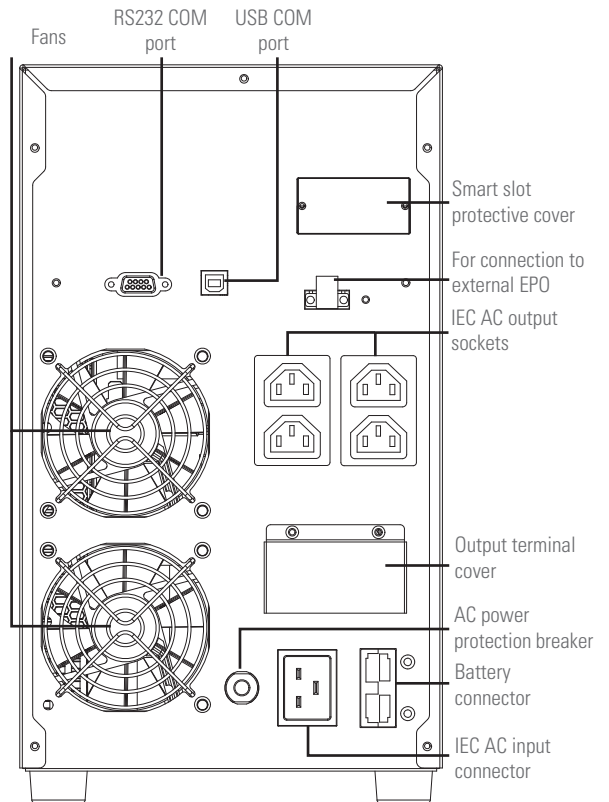

Rear view of the B1 device.

Fig. 4. Rear views of devices according to power.

Battery modules for 1000 to 2000 VA devices.

Battery module for 3000 VA devices.

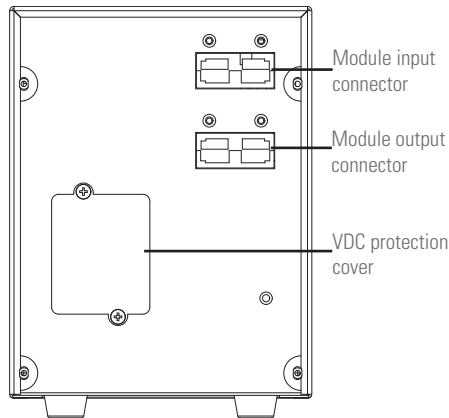

Rear view of the battery module.

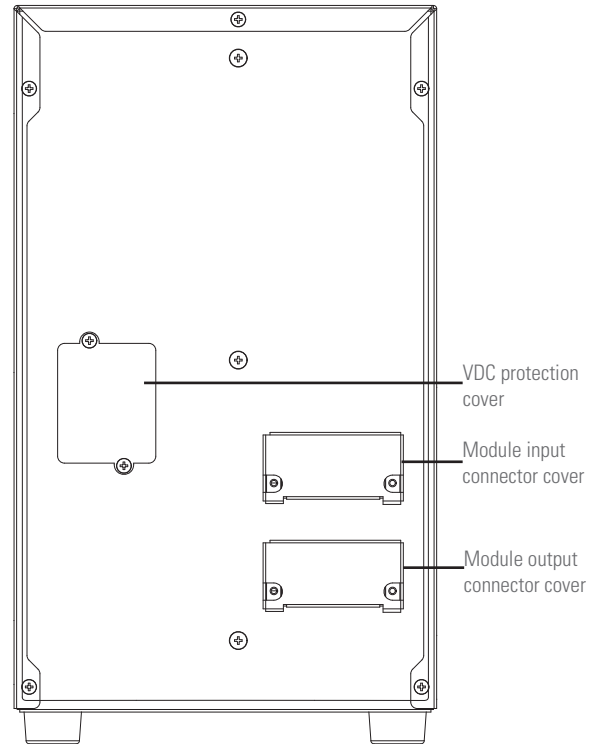

Rear view of the battery module.



Connection of the battery module to the device and/or other module is made through the respective connectors.

Fig. 5. Rear views of battery modules for extended backups.

4.2. DEFINITION OF THE PRODUCT.

4.2.1. Nomenclature.

SPS 1000 ADV T B1 WCO 220/220 EE29503

_____	EE	Special customer specifications.
_____	220	Output voltage. Skip for 230 V.
_____	220	Input voltage. Skip for 230 V.
_____	CO	'Made in Spain' marking on UPS and packaging (for customs purposes).
_____	W	Private-label device.
_____	B1	Device with extra charger and batteries external to the UPS.
_____	ADV R	Rack format device series.
_____	ADV T	Tower format device series.
_____	1000	Power in VA.
_____	SPS	Acronym for interactive UPS (Standby Power Systems).

MOD BAT ADV T 2x6AB003 3x40A WCO EE29503

_____	EE	Special customer specifications.
_____	CO	'Made in Spain' marking on UPS and packaging (for customs purposes).
_____	W	Private-label device.
_____	40A	Protection size.
_____	3x	Number of protections in parallel. Omit for one.
_____	003	Last three digits of the battery code.
_____	AB	Initials of the battery family.
_____	6	Number of batteries in one branch.
_____	2x	Number of branches in parallel. Omit for one.
_____	0/	Battery module without them, but with the necessary accessories to install them.
_____	ADV T	Battery module series.
_____	MOD BAT	Battery module.



Note related to B1 batteries:

(B1) Device with a more powerful charger, which does not have a battery pack, nor the possibility of installing them in the same box.

If an accumulator module is required, it will need to be ordered as a separate item, which will be connected to the UPS using the supplied cable.

Before connecting a module or group of batteries to the device or another available module, **it is necessary to check** that the voltage value printed on the back of the device next to the battery connector is appropriate and that the polarity between the means of connection corresponds.

For more information, see Chapter 9 of this document.

4.3. OPERATING PRINCIPLE.

This user manual describes the installation and mode of operation of SPS ADVANCE R and SPS ADVANCE T series UPSs indicated in Tab. 1 and Tab. 2.

These line-interactive pure sine-wave output devices are designed to protect your most sensitive electronic devices against power supply problems including undervoltages, spikes, prolonged voltage drops, line noise and mains failures.

With the device running and the mains supply correct, the load or loads are powered through the stabiliser featuring buck-boost technology. Any possible variations in the input voltage are corrected by the stabiliser module while they are within its regulation range.

With mains supply absent or voltage and/or frequency outside the range, the load or loads will be powered from the batteries through the inverter for a certain period of time depending on the model, battery charge level and load itself connected to the output.

When plugged into an AC socket, the batteries are set to charge mode regardless of whether the device is on or off.

In SPS ADVANCE T 1000 to 3000 VA models, it is possible to increase the standard backup of the devices by connecting additional modules and/or optimising the recharge time of the accumulators by incorporating higher performance chargers (B1). The entire power range of SPS ADVANCE R and T models enables:

- Serial port for communication and control of the device. The serial port supports communications directly with a server and the protocol is in accordance with an RS232 interface. SPS ADVANCE T models also have an additional USB serial port for communication and control of the device. It is not possible to use the RS232 and USB ports at the same time.
- An EPO connector for optional, external installation by the user of an emergency stop button.
- A smart slot in which one of the following communication cards can be installed:
 - Integration into computer networks using an SNMP adapter.

4.3.1. Operating diagram

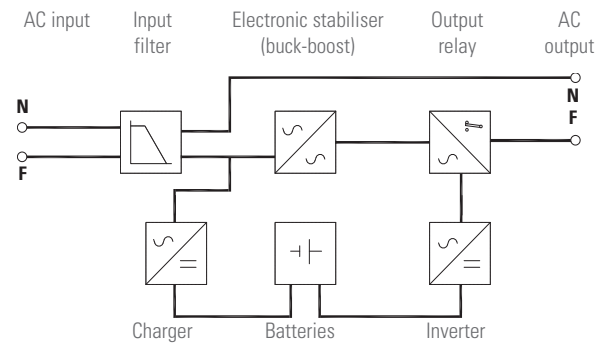

Fig. 6. Operating diagram.

4.3.2. Notable features.

- Pure sine-wave output waveform, suitable for all types of load.
- Possibility of starting the device without mains power (cold start).
- Great adaptability to the worst conditions of the mains. Wide input voltage, frequency and waveform ranges, thus avoiding excessive dependence on limited battery power.
- If mains supply is present and voltage and frequency are within the range, the built-in stabiliser featuring buck-boost technology powers the loads.
- Compatibility with APFC loads.

The vast majority of power supplies for electronic devices are switched-mode (SMPS) and they are increasingly being equipped with active power factor correction (APFC) to minimise distortion caused to the electrical line. SPS HOME UPSs are compatible with all devices that incorporate these functionalities.

- Possibility of fast and easy backup extension by adding battery modules ⁽¹⁾.
- Availability of additional battery chargers to reduce battery recharge time (B1) ⁽¹⁾.
- Intelligent battery management technology is very useful for extending the life of accumulators and optimising recharge times.
- Control panel with LCD display available on all models.
- Remote emergency power off control (EPO).
- Serial communication port: RS232 and USB ⁽¹⁾.
- Availability of optional connectability cards to improve communication capabilities.
- Protection against overload, short circuit and overtemperature.

⁽¹⁾ Only in SPS ADVANCE T models.

Model	Type	Input/output type
SPS 750 ADV R	Standard	Single-phase / Single-phase.
SPS 1000 ADV R		
SPS 1500 ADV R		

Tab. 1. SPS ADVANCE R standardised models.

Model	Type	Input/output type
SPS 850 ADV T	Standard	Single-phase / Single-phase.
SPS 1000 ADV T		
SPS 1500 ADV T		
SPS 2000 ADV T		
SPS 3000 ADV T		
SPS 1000 ADV T (B1)	Long backup with additional charger	
SPS 1500 ADV T (B1)		
SPS 2000 ADV T (B1)		
SPS 3000 ADV T (B1)		

Tab. 2. SPS ADVANCE T standardised models.

4.4. OPTIONAL EXTRAS.

Depending on the configuration chosen, the device may include any of the following options:

4.4.1. Isolation transformer:

The isolation transformer provides galvanic isolation in order to completely isolate the output from the input and/or change neutral mode.

The placement of an electrostatic screen between the primary and secondary windings of the transformer provides a high level of electrical noise attenuation.

The isolation transformer can be physically placed at the input or output of the UPS depending on the technical conditions of the whole system (device supply voltage and/or load voltage, characteristics or their type, etc.).

In any event, it will always be supplied as a peripheral component external to the device itself in a separate box.

4.4.2. Communication card.

The UPS features a slot at the rear for inserting one of the following communication cards.

4.4.2.1. Integration into computer networks using an SNMP adapter.

Large computer systems based on LANs and WANs that integrate servers in different operating systems must provide the system manager with ease of control and administration. This facility is obtained through an SNMP adapter, which is universally supported by the main software and hardware manufacturers.

Connection of the UPS to the SNMP is internal while that of the SNMP to the computer network is made through a RJ45 10 base connector.

4.4.3. Extendable guide kits for mounting in a rack cabinet (only in SPS ADVANCE R models).

An extendable and unique guide kit is available for all SPS ADVANCE R device models, valid for any kind of rack-type cabinet.

5. INSTALLATION.

-  Read and respect the Safety Information, described in chapter 2 of this document. Failure to obey some of the instructions described in this manual can result in a serious or very serious accident to persons in direct contact or in the vicinity, as well as faults in the equipment and/or loads connected to it.

5.1. RECEPTION OF THE DEVICE.

- Pay attention to section 1.2.1. of the safety instructions -EK266*08- in all matters relating to the handling, movement and siting of the unit.
- Use the most appropriate means to move the UPS.
- Any handling of the device must be carried out in accordance with the weights shown in the technical specifications according to the model, indicated in chapter "9. Annexes".

5.1.1. Reception, unpacking and contents.

- Reception. Check that:
 - The data on the label affixed to the packaging corresponds to that specified on the order. Once the UPS is unpacked, check the previous data with those of the equipment nameplate.
If there are discrepancies, file the disagreement as soon as possible, citing the equipment manufacture number and the delivery note references.
 - There is no damage to the packaging that may have occurred during transportation.
If there is damage, notify the carrier and indicate so on the delivery note, and, as soon as possible, inform the supplier / distributor or, failing that, our firm.
- Unpacking.
 - Remove the packaging to check the contents.
 - Cut the seal and open the cardboard box.
 - Remove:
 - The bag containing cable or cables.
 - The bag containing ADVANCE R mechanical elements (angles, screws, etc.).
 - The input power cable.
 - Remove the device and plastic bag from the packaging and detach the protective corners.
 - Inspect the device before proceeding and, in the event of finding damage, contact the supplier / distributor or, failing that, our firm.
 -  Do not leave any plastic bags within the reach of children to avoid the danger of suffocation.
 - Disposal of the packaging must be carried out in accordance with current laws.
We recommend keeping it for at least one year.
- Contents.
 - Device:
 - 1 UPS.
 - Quick guide on paper.
 - Information for warranty registration.
 - 1 RS232 cable.
 - 1 USB cable (only in SPS ADVANCE T models).
 - 1 cable for the device's AC power supply.

- 2 metal pieces for use as handles and screws for installing the unit in a rack cabinet (only in SPS ADVANCE R models).
- Optional battery module (only in ADVANCE T models):
 - 1 battery module:
 - Information for warranty registration.
 - 1 cable for interconnecting the battery module and UPS or other module.
- Once the reception is completed, it is advisable to re-pack the UPS until it is put into service in order to protect it against mechanical shock, dust, dirt, etc.

5.1.2. Storage.

- Equipment storage shall be done in a dry, ventilated place and protected from rain, dust, water splashes or chemical agents. It is advisable to keep each device and battery unit in its original packaging, as it has been specifically designed to ensure maximum protection during transportation and storage.
-  For devices that contain Pb-Ca batteries, the charging times indicated in Tab. 2 of document EK266*08, determined by the temperature to which they are exposed, must be respected, otherwise the warranty may be invalidated.
- After this period, connect the device to the mains together with the battery unit if applicable according to the instructions described in this manual and charge for 12 hours.
- Then disconnect and store the UPS and batteries in their original packaging, noting the new date for recharging the batteries on a document as a record or even on the packaging itself.
- Do not store the devices where the ambient temperature exceeds 50°C or drops below -20°C, as this may cause degradation of the electrical characteristics of the batteries.

5.1.3. Transport to the site.

- It is advisable to move the UPS using the most suitable means for this. If the distance is considerable, it is recommended to transport the device in its packaging to the installation site and then unpack it.

5.1.4. Siting, immobilising and considerations.

- The ADVANCE R models are designed for mounting as a rack (installation in 19" cabinets and in horizontal position (see section 5.1.4.1) and the ADVANCE T models as a tower (in vertical position), just like their optional battery modules.
- For all instructions regarding connections, refer to section 5.2.

5.1.4.1. Rack-type mounting in a 19" cabinet (SPS ADVANCE R devices).

- Proceed as follows (see Fig. 7):
 - ❑ Using the supplied screws, fix the two adapter angles for use as handles on each side of the UPS, respecting its mounting orientation.
 - ❑ To install the device in a rack cabinet, it is necessary to have internal lateral guides for use as supports. Alternatively, and upon request, we can supply universal slides for use as guides, for installation by the user.

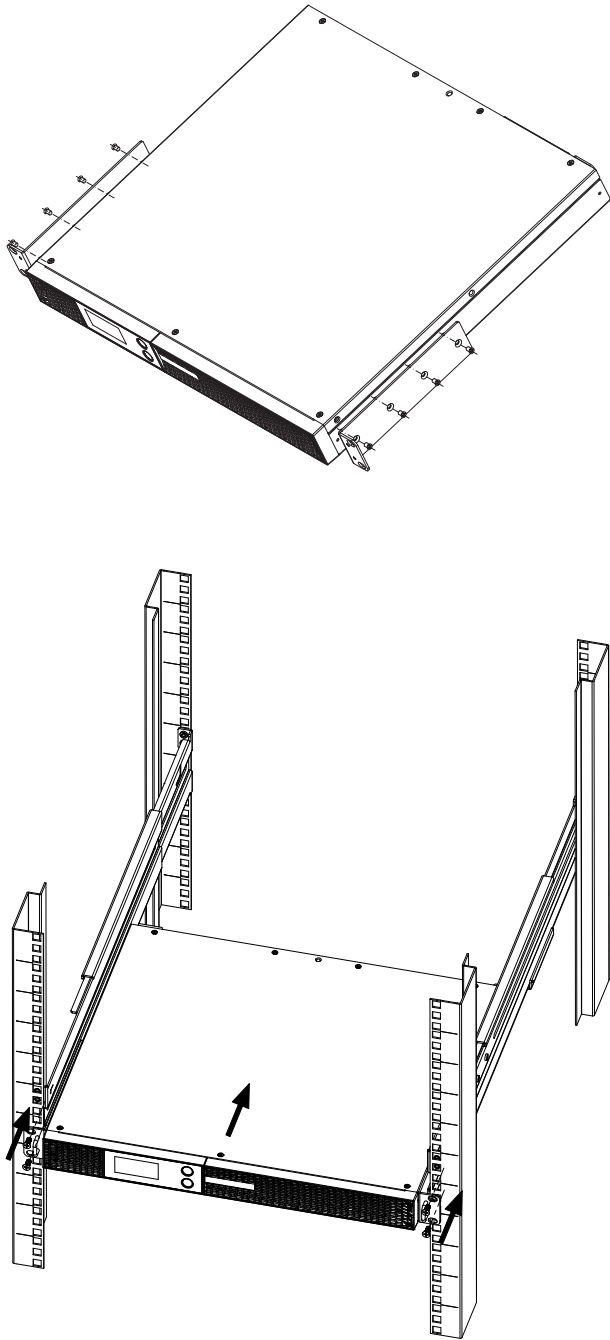

Fig. 7. SPS ADVANCE R mounting in a 19" cabinet.

- ❑ Mount the guides at the required height, ensuring correct tightening of the fixing screws and appropriate fitting in the machining, according to each case.
- ❑ Place the device onto the guides and insert it all the way to the back.

Depending on the device model and weight, and/or whether it is installed in the upper or lower part of the cabinet, it is recommended that two people carry out the installation operations.
- ❑ Fix the UPS to the cabinet frame using the screws supplied with the handles.

5.1.4.2. Preliminary considerations before connection.



- Check that the information on the device's nameplate is that required for installation.
- Thermal control of the ADV T models is carried out with the passage of forced air from the front to the rear. 10 cm on the front surface and its rear side should be left free of obstructions to facilitate the free circulation of air for ventilation.
- Protection board:

It will have a type-B differential circuit breaker and a short circuit protection (C-curve circuit breaker) for the UPS's input line



As for size, they will be at least the current indicated on the nameplate of the UPS.
- Only the rated current as indicated by the EN-IEC 62040-1 safety standard is printed on the nameplate of the device. For the calculation of the input current, the power factor and the equipment's own performance have been considered. Overload conditions are considered a non-permanent and exceptional working mode.
- The cross section of the input line cables is determined by the current indicated on the nameplate of each device, in compliance with local and/or national Low-Voltage Electrotechnical Regulations.
- If peripheral input and/or output elements, such as transformers or autotransformers, are added to the UPS, the currents indicated on the nameplates of these elements must be taken into consideration when determining appropriate cross sections, in compliance with local and/or national Low Voltage Electrotechnical Regulations.
- ⚠ When a device incorporates a galvanic isolation transformer as an optional extra or installed independently, either at the input, output or both, it must be fitted with protection against indirect contact (differential circuit breaker) at the output of each transformer, since, due to its own insulation properties, it will prevent the tripping of the protections placed on the primary of the isolation transformer in case of electric shock on the secondary (output of the isolation transformer).
- We remind you that all the isolation transformers installed or factory supplied, have the output neutral grounded through a bridge between the neutral terminal and ground. If the isolated output neutral is required, this bridge must be removed, taking the precautions indicated in the respective local and/or national low voltage regulations.

-  This device is suitable for installation in networks with TT, TN-S, TN-C or IT power distribution systems, taking into account at the time of installation the particularities of the system used and the national electrical regulations of the destination country.
- ADVANCE R and T models feature terminals for the installation of an external emergency power off button (EPO) or, failing that, a single device must be installed to cut the power supply to the loads in any operating mode.



5.1.4.3. Preliminary considerations before connection, regarding the batteries and their protections.

- SPS ADVANCE R and T devices incorporate the batteries in the same box as the device, except for SPS ADVANCE T B1 devices.
The UPS's battery protection is internal by means of fuses and is therefore not accessible to the user.
-  **IMPORTANT FOR SAFETY:** If batteries are installed independently, the accumulator group must be fitted with a bipolar circuit breaker or disconnect fuse of the size indicated in Tab. 3.
- Inside the battery module, there are HAZARDOUS VOLTAGES with risk of electric shock, so it is classified as a RESTRICTED ACCESS AREA.
-  If the mains power of the device is cut for longer than a simple intervention and it is expected that it will be out of service for a prolonged period time, the system must be shut down completely.
-  The battery circuit is not isolated from the input voltage. Dangerous voltages can occur between the terminals of the battery group and the earth. Check that there is no input voltage before working on the battery module connectors.

5.2. CONNECTIONS.

- A bad connection or operation can cause faults in the UPS and/or the loads connected to it. Read the instructions in this manual carefully and follow the steps indicated in the order established.
-  The devices can be installed and used by personnel without specific training by simply using this manual.
-  It should never be forgotten that a UPS is a generator of electrical energy, and as such, the user must take all necessary precautions against direct or indirect contact.
-  All of the device's connections, including those related to control (interface, EPO, etc.), must be made without mains power present and the UPS set to 'Off.'
- To connect a device to an optional battery module, or between modules, or to install an optional card in the slot, it is necessary to remove its respective metal protective cover screwed to the UPS. Remove the screws and cover.



5.2.1. Connection of the input.

-  As the device has Class I protection against electric shock, it is obligatory and essential for the AC input socket to have the earth conductor () installed. Check that this is the case before continuing.
- Take the device's power cable, plug the female IEC connector into the UPS and the Schuko plug at the other end of the cable into an AC power socket.



5.2.2. Connection of the IEC output connectors.

- All UPSs have "n" variable IEC output connectors according to the model of the device.
-  Loads can be connected to all of the IEC connectors provided that the rated power of the device is not exceeded, otherwise untimely cuts will occur in the powering of the loads connected to them.
- If, in addition to the more sensitive loads, it is necessary to connect high-consumption inductive loads, such as for laser printers or CRT monitors, the starting up of these peripherals will need to be taken into account to prevent the device from crashing.
We do not recommend connecting loads of this type due to the amount of power they absorb from the UPS.

5.2.3. Output terminals (only in SPS ADVANCE T 3KVA models).



-  As the device has Class I protection against electric shock, it is obligatory and essential to connect the earth conductor () to each group of input terminals. Check that this is the case before continuing.
- The cross section of the input cables must be appropriate for the current of the device, in compliance with local and/or national Low-Voltage Electrotechnical Regulations.
- Connect the output cables, respecting the order of the phase, neutral and earth connection indicated on the labelling.

5.2.4. Connection to the optional battery module (backup extension).

-  **Failure to comply with the instructions in this section and Safety Instructions EK266*08 carries a high risk of electric shock and even death.**
- SPS ADVANCE R and T devices incorporate the batteries in the same box as the device, except for SPS ADVANCE T B1 devices.
-  **IMPORTANT FOR SAFETY:** If batteries are installed independently, the accumulator group must be fitted with a bipolar circuit breaker or disconnect fuse of the size indicated in Tab. 3.

Model	Rated voltage of batteries	Minimum values, fast type fuses	
		DC voltage (V)	Current (A)
SPS 1000 ADV T	(12 V x 2) = 24 V	125	50
SPS 1500 ADV T			63
SPS 2000 ADV T			100
SPS 3000 ADV T	(12 V x 4) = 48 V		63

Tab. 3. Protection features between device and battery module.

-  Before starting the connection process between the battery module or modules and the device, check that the UPS and the loads are set to 'Off' and that the battery voltage of all of them is the same, without exceptions. Also, when the batteries are installed by the user independently, the protection fuse or isolator must be deactivated.
- Connection of the battery module to the UPS is made by means of a cable featuring polarised connectors at both ends and supplied with the first one. Plug the connector at one end of the cable into the corresponding socket on the SPS ADVANCE T and the one on the other end into the battery module (see Fig. 8). In the same way, battery modules can be linked in parallel since each of them has two connectors. All of the connectors must be secured to their units by means of the screws that held the protective cover of each connector to the UPS or battery module.
-  Each battery module is independent for each device. **Two devices must not be connected to the same battery module.**
- Fig. 8 shows, by way of example, the connection of a 3 kVA device to two battery modules. For a larger number, proceed in a manner similar to those shown in the illustration.

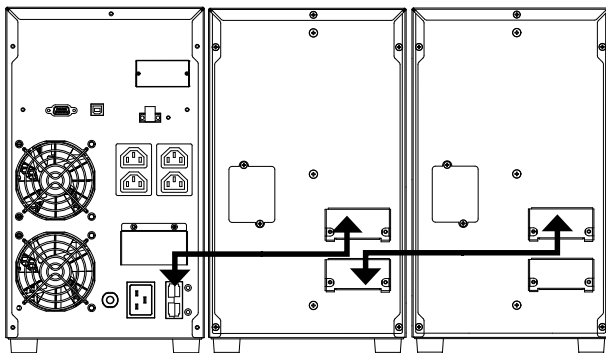

Fig. 8. Connection to battery modules.

5.2.5. Terminals for EPO (emergency power off).

- The UPSs have two terminals for the installation of an external emergency power off (EPO) output button.
- The device is dispatched from the factory with its EPO circuit set to closed (NC) by default. In other words, the UPS will cut the output power supply, emergency power off, when the circuit is opened:
 - Either by removing the female connector from the socket where it is inserted. This connector has a cable connected as a jumper that closes the circuit (see Fig. 9A).

- Or by pressing the button external to the device belonging to the user installed between the terminals of the connector (see Fig. 9B). The connection on the button must be in the normally closed contact (NC), so it will open the circuit when activated.
- To recover the normal operating state of the UPS, it is necessary to insert the connector with the jumper in its receptacle or deactivate the EPO button. The device will be operational.

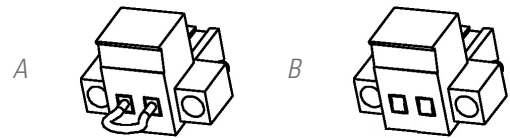



Fig. 9. Connector for external EPO.

5.2.6. Communication port.

5.2.6.1. RS232 and USB port.

-  The communications line -COM- constitutes a very low voltage safety circuit. To preserve the quality, it must be installed separately from other lines carrying dangerous voltages (power distribution line).
- The RS232 and USB interfaces are useful for the monitoring software and updating the firmware.
- It is not possible to use both the RS232 and USB ports at the same time.
- The RS232 port consists of the transmission of serial data in such a way that a large amount of information can be sent through a 4-wire communication cable.
- The USB port is compatible with the USB 1.1 protocol for communication software.

Pin #	Description	Input / Output
2	TXD	Output
3	RXD	Input
4	DTR	Output
5	GND	Earth

Tab. 4. Pinout of DB9 connector, RS232.

Pin #	Signal
1	V BUS-
2	D -
3	D +
4	GND

Tab. 5. Pinout of the USB connector.

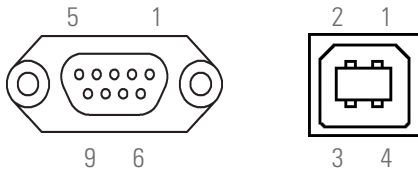

Fig. 10. DB9 connectors for RS232 and USB.

5.2.7. Smartslot for the integration of an electronic communication unit (SNMP).

- The corresponding documentation is supplied with the option. Read it before starting installation.

Installation.

- Remove the protective cover from the device's slot.
- Take the corresponding electronic unit and insert it into the reserved slot. Make sure that it is properly connected, for which it is necessary to overcome the resistance caused in the connector located in the slot.
- Make the necessary connections in the terminal block or connectors available according to each case.
- For more information, contact our **T.S.S.** or our nearest distributor.

5.2.8. Management and monitoring software.

- Through the RS232 or USB port and the free management and monitoring software, which can be downloaded from our Website, it is possible to display the values of the different parameters of the Input, batteries and Output on a PC screen, and close files and applications.

The software can be downloaded in two different ways.

- Ideally by registering the product. This facilitates and streamlines warranty procedures in the event of incidents:
 - Enter the following in the browser's address bar:
<https://support.salicru.com>
 - Click the 'Enter' key. The Website's On-Line Support page will be displayed on the screen.
 - Register as a user.
 - Register the product purchased with all of the details requested.
 - Documentation relating to the model, and management and monitoring software, will be displayed with the available operating systems.
Download the required software and install it.
- Directly through the Website.
 - Enter the following in the browser's address bar:
<https://www.salicru.com/>
 - Click the 'Enter' key. The page shows two sections on the screen. Search for the device series within them or via the 'Product' header menu, which is structured in the same way.
 - When accessing the device series, you will see below the illustrations links to the different documentation and below these, some tabs, among them the one marked Software.
Select the Software with the required operating system, download it and install it.

5.2.9. Considerations before start-up with connected loads.

-  It is recommended to charge the batteries for at least 12 hours before using the UPS for the first time.
 - For this, it will be necessary to supply voltage to the device. The battery charger will work automatically.
 - For the battery modules.
For models with batteries external to the device or backup extension modules, firstly connect the batteries to the device before connecting it to the AC mains.
- Although the device can operate correctly without charging the batteries for the specified 12 hours, the risk of a prolonged power cut during the first hours of operation and the UPS's available backup time should be assessed.
- Do not start up the device and loads completely until indicated in Chapter 6.
When it is done, however, it should be carried out gradually to avoid possible difficulties, if not at the first start-up.
- If, in addition to the more sensitive loads, it is necessary to connect high-consumption inductive loads, such as for laser printers or CRT monitors, the starting up of these peripherals will need to be taken into account to prevent the device from crashing.

6. OPERATION.

6.1. STARTUP.

6.1.1. Checks before start-up.

- Make sure that all of the connections have been made correctly, following the instructions on the labelling of the device and in Chapter 5.
- Make sure that all loads are 'Off'.
 Check that all loads are 'Off.' Do not start them until indicated and, when it is, do so gradually. Before shutting down the UPS, check that all of the loads are 'Off.'
- It is very important to proceed in the established order.
- For device illustrations, see Fig. 1 to Fig. 5.
- Supply voltage to the device (turn the input protection on the distribution board to 'On').

6.2. UPS START-UP AND SHUTDOWN.

6.2.1. UPS start-up with mains voltage.

- The LCD display illuminates and shows the value of the input voltage with the battery being charged (cyclic movement of the BATT bar segments), while they are not charged.
-  The backlight of the control panel will turn off after approximately 1 minute if no buttons are pressed.
 - Press the ON/OFF button for more than 2 seconds, the audible alarm will sound for 1 s, the UPS will start up and an automatic battery test lasting 10 seconds will begin. After this time elapses, the UPS will be set to "Normal mode". If the mains voltage is incorrect, the UPS will switch to "Battery mode", without interrupting the power supply at the output terminals while it has backup.
- Start the load or loads, making sure that the rated power of the device is not exceeded.
- In the ADVANCE T, the fan or fans, according to the model, will be put into operation depending on the % of load connected to the output.
Then the main start screen will be displayed after a test of the device.

6.2.2. UPS start-up without mains voltage.

- Press the ON/OFF button for more than 2 s, the audible alarm will sound for 1 s and the UPS will start up.
 Consider the level of charge of the batteries and consequently the available backup.
- Start the load or loads, making sure that the rated power of the device is not exceeded.
- If the mains voltage returns, the UPS will transfer to "Normal mode" without interrupting the power supply at the output.
- In the ADVANCE T, the fan or fans, according to the model, will be put into operation depending on the % of load connected to the output.

6.2.3. UPS shutdown with mains voltage.

- Shut down the load or loads.
- Press the ON/OFF button for more than 2 seconds to shut down the UPS. The audible alarm will sound for 1 second. The device is in Standby (no output voltage) and charging batteries.

6.2.4. UPS shutdown without mains voltage.

- Shut down the load or loads.
- Press the ON/OFF button for more than 2 s to shut down the inverter. The audible alarm will sound for 1 second. The device will leave the output without voltage. A few seconds later, the LCD screen turns off and the entire device will be out of service.
- To leave the assembly completely isolated, turn the input switch on the board to "Off".

7. CONTROL PANEL WITH LCD DISPLAY.

7.1. COMPOSITION OF THE CONTROL PANEL WITH LCD DISPLAY.

- The control panel consists of:
 - Two buttons with the functions described in Tab. 6.
 - An LCD display with backlighting.

SPS Advance R display.

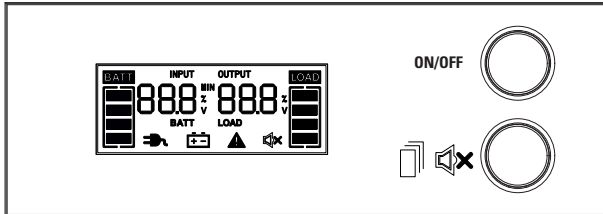

SPS Advance T display.

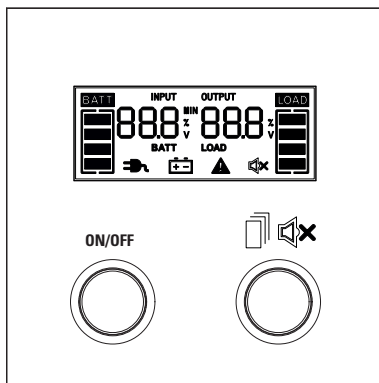

Fig. 11. View of the SPS ADVANCE R and T control panel.

7.2. GENERAL INFORMATION.

7.2.1. Information represented by the display.

Information on input voltage, battery % and backup time (backup for B1 devices not shown)

Information on battery charge level (each segment is equivalent to 25%)

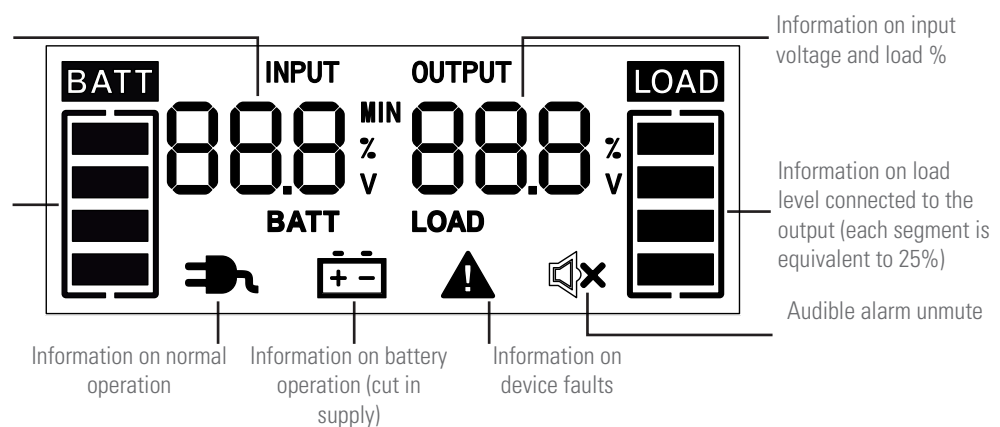









Fig. 12. Graphic and textual information shown on the display.

Button	Description
ON/OFF	- Starting up the UPS. With the UPS off, press the button for at least 2 s
	- Shutting down the UPS. With the UPS on, press the button for at least 2 s
	- Reading the parameters. By pressing the button, the following is displayed cyclically: <ul style="list-style-type: none"> - input and output voltage - backup time - % level of battery charge and % level of the loads.
	- Muting the alarm. Press the button for at least 3 seconds to mute or unmute the audible alarm. It is only possible to mute the battery discharge alarm, which necessarily means that the device is running and operating in battery mode. Any other warning or error alarm cannot be muted.

Tab. 6. Functionality of the control panel buttons.







Tables 7, 8 and 9 show the information that appears on the display depending on the working mode of the UPS.

- Information represented in Line mode.

Select SW button	State of the UPS				Level		Value				
							INPUT 888 ^{MIN} _{BATT} $\frac{\%}{V}$		OUTPUT 888 $\frac{\%}{V}$ LOAD		
	Input voltage	Backup time	Battery level	Output voltage	Charge level						
Start	V	X	X	-	V	V	V			V	
1st click	V	X	X	-	V	V		V			
2nd click	V	X	X	-	V	V			V		V
3rd click (return to Start)	V	X	X	-	V	V	V			V	
Press > 3 sec (disable audible warning)	V	X	X	V	-	-	-	-	-	-	-
Repeat press > 3 sec (enable audible warning)	V	X	X	X	-	-	-	-	-	-	-
Overload and fault alarm	V	X	V+Error code	-	-	-	-	-	-	-	-
Other alarms and faults	X	X	V+Error code	-	-	-	-	-	-	-	-







Tab. 7. On-line operating mode.

- Information represented in Standby mode.

Select SW button	State of the UPS				Level		Value				
							INPUT 888 ^{MIN} _{BATT} $\frac{\%}{V}$		OUTPUT 888 $\frac{\%}{V}$ LOAD		
	Input voltage	Backup time	Battery level	Output voltage	Charge level						
Start	V	X	X	-	V	V	V			V	
Press > 3 sec (disable audible warning)	V	X	X	V	-	-	-	-	-	-	-
Repeat press > 3 sec (enable audible warning)	V	X	X	X	-	-	-	-	-	-	-
Other alarms and faults	V	X	V+Error code	-	-	-	-	-	-	-	-

Tab. 8. Standby operating mode.

- Information represented in Battery mode.

Select SW button	State of the UPS				Level		Value				
							INPUT			OUTPUT	
							888 ^{MIN} % V	BATT	888 % V	LOAD	Charge level
							Input voltage	Backup time	Battery level	Output voltage	Charge level
Start	X	V	X	-	V	V	V			V	
1st click	X	V	X	-	V	V		V			
2nd click	X	V	X	-	V	V			V		V
3rd click (return to Start)	X	V	X	-	V	V	V			V	
Press > 3 sec (disable audible warning)	X	V	X	V	-	-	-	-	-	-	-
Repeat press > 3 sec (enable audible warning)	X	V	X	X	-	-	-	-	-	-	-
Fault and overload alarm	X	V	V+Error code	-	-	-	-	-	-	-	-
Other alarms and faults	X	X	V+Error code	-	-	-	-	-	-	-	-

Tab. 9. Battery operating mode.

7.3. AUDIBLE ALARMS.

Description	Alarm modulation or tone	Possibility of muting
State of the UPS		
Battery mode	Beep every 30 s	Yes
Warning		
Low battery	Beep every 2 s	No
Overload	Beep every 0.5 s	
Fault		
Fault	Continuous.	No

Tab. 10. Audible alarms.

7.4. WARNING AND ERROR OR FAULT CODES.

Code	Description of the warning
A56	Low battery voltage warning.
A57	Low battery capacity warning.
A59	Disconnected battery warning.
A62	Defective battery warning.
A64	Overload warning.
A66	EPO activated warning.
A68	Overtemperature warning.
A86	Low inverter output voltage warning.

Tab. 11. Warning code.

Code	Error or failure description
E06	Inverter soft-start fault.
E07	High inverter voltage.
E08	Low inverter voltage.
E09	Short circuit at the output.
E11	High battery voltage.
E12	Low battery voltage.
E14	Overload at the output.
E15	Unbalanced loads.
E18	Fan fault.
E19	Overtemperature.

Tab. 12. Error or fault code.

8. MAINTENANCE, WARRANTY AND SERVICE.

8.1. BATTERY MAINTENANCE.

- Pay attention to all of the safety instructions concerning batteries indicated in section 1.2.3 of manual EK266*08.
- The service life of the batteries greatly depends on the ambient temperature and other factors such as the number of charges and discharges, as well as their depth. The service life is designed to be between 3 and 5 years if the ambient temperature is between 10 and 20°C. Different types of battery with different service lives are available upon request.
- SPS.ADVANCE R and T series UPSs require minimum upkeep. The batteries used in the standard models are lead acid, sealed, valve regulated and maintenance free. The only requirement is to charge the batteries regularly to extend their life expectancy. While it is connected to the mains supply, whether or not it is running, it will keep the batteries charged and also offer protection from overcharging and deep discharge.

8.1.1. Notes for the installation and replacement of the battery.

- If it is necessary to replace any connection cables, original materials can be purchased through our **T.S.S.** or authorised distributors. Using inappropriate cables can lead to overheating in connections, which is a fire hazard.
-  Inside the device, there are permanent dangerous voltages even without mains supply present through its connection with the batteries and especially in UPSs where the electronics and batteries share a box. Also take into consideration that the battery circuit is not

isolated from the input voltage, so there is a risk of discharge with dangerous voltages between the battery terminals and the earth terminal, which is in turn connected to earth (any metal part of the device).

- Repair and/or maintenance work must be carried out by our **T.S.S.**, except for the replacement of batteries, which can be performed by qualified personnel familiar with them. No other person should handle them.

8.2. UPS TROUBLESHOOTING GUIDE.

If the UPS does not work properly, check the information shown on the LCD screen of the control panel and act accordingly depending on the device model.

Using the Tab. 13 troubleshooting guide, try to resolve the issue and, if it persists, consult our Technical Service and Support **T.S.S.**

If it is necessary to contact our Technical Service and Support **T.S.S.**, provide the following information:

- UPS model and serial number.
- Date on which the issue occurred.
- Full description of the issue, including information provided by the LCD display or LEDs and state of the alarm.
- Power supply conditions, type of load and level of load applied to the UPS, ambient temperature, ventilation conditions.
- Battery information (capacity and number of batteries), if the device is (B1).
- Any other information considered relevant.

Symptom	Possible cause	Solution
Abnormal		
Mains normal but does not work in line mode.	No input voltage.	Check AC input connection.
	Input protection tripped.	Unplug UPS power cord and then reset protection.
UPS does not start.	UPS not connected to an AC socket.	Unit must be connected to a 220-240V 50 / 60Hz socket.
	Batteries damaged.	Contact distributor, seller or, failing that, our T.S.S.
	UPS faulty.	Contact distributor, seller or, failing that, our T.S.S.
Output sockets do not supply power to the device.	Input protection tripped by overload.	Disconnect non-essential loads from the device and reset input protection.
	Battery discharged.	Charge battery for at least 4 hours.
	UPS faulty.	Contact distributor, seller or, failing that, our T.S.S.
Warning Codes		
A56	Low battery voltage: Battery voltage too low, device will turn off.	Check AC input connection. Disconnect loads in battery mode.
A57	Low battery capacity: Battery capacity too low.	Check AC input connection. Disconnect loads in battery mode.
A59	Disconnected battery: Device without connected battery.	Stop device. Connect battery to device.
A62	Faulty batteries: Battery damaged.	Stop device. Change batteries.
A64	Overload: Loads excessive for device.	Disconnect non-essential loads from device.

Symptom	Possible cause	Solution
A66	EPO activated: Open EPO terminals	Connect EPO terminals
A68	Overtemperature: Ambient temperature too high.	Disconnect non-essential loads from device. Check that fan is working correctly and that UPS's air inlets and outlets have not been blocked.
A86	Low inverter output voltage: Low inverter output voltage protection will be activated.	Check AC input connection. Disconnect loads.
Error Codes		
E6	Inverter soft-start fault: Device starting fault.	Contact distributor, seller or, failing that, our T.S.S.
E7	High inverter output voltage: Inverter output voltage too high.	Turn off UPS. Disconnect non-essential loads from device.
E8	Low inverter output voltage: Inverter output voltage too low	Turn off UPS. Disconnect non-essential loads from device.
E9	Output short circuit	Turn off UPS. Loads may have a problem, disconnect and check them.
E11	High battery voltage.	Turn off UPS. Check battery voltage.
E12	Low battery voltage.	Turn off UPS. Check battery voltage. Check battery cable terminals on B1 devices.
E14	Overload at the output.	Disconnect non-essential loads. If overload problem solved, devices will go into normal mode.
E15	Unbalanced loads.	Turn off UPS. Check device's loads.
E18	Fan fault.	Contact distributor, seller or, failing that, our T.S.S.
E19	Overtemperature.	Turn on again and check that fan is working correctly and that UPS's air inlets and outlets have not been blocked.

Tab. 13. Troubleshooting guide.

8.3. WARRANTY CONDITIONS.

8.3.1. Terms of the warranty.

On our website you will find the warranty conditions for the product you have purchased where you can also register it. It is recommended to do so as soon as possible to include it in the database of our Technical Service and Support (**T.S.S.**). Among other advantages, it will streamline any regulatory procedures for the intervention of **T.S.S.** in the event of a fault.

8.3.2. Exclusions.

Our company will not be bound by the warranty if it notices that the defect in the product does not exist or was caused by improper use, negligence, improper installation and/or verification, attempts at unauthorized repair or modification, or any other cause beyond the intended use, or by accident, fire, lightning or other hazards. Nor shall it cover any compensation for damages.

8.4. TECHNICAL SERVICES NETWORK.

Information about our national and international Technical Service and Support (**T.S.S.**) centres can be found on our website.

9. ANNEXES.

9.1. GENERAL TECHNICAL SPECIFICATIONS.

Models.	ADVANCE R		
Available power ratings (VA / W).	750VA / 450W	1000VA / 600W	1500VA / 900W
Technology.	Line-interactive with sine-wave output.		
Input.			
Input type.	Single-phase.		
Number of cables.	3 cables - Phase R (L) + Neutral (N) and earth.		
Rated voltage.	220 / 230 / 240 V AC		
Input voltage range.	165..290 V AC		
Input frequency range.	50 / 60 Hz (auto-detectable).		
Inverter.			
Waveform.	Pure sine wave.		
Power factor.	0.6		
Rated voltage.	220 / 230 / 240 V AC		
Output voltage accuracy (battery mode).	±10%		
Total harmonic distortion (THDv), with linear load.	< 5 % linear load <10 % non-linear load		
Frequency.	50 / 60 Hz. With mains absent -backup mode- 50 / 60 ±1% Hz.		
Transfer time, line mode to battery mode (normal mode).	4 ms		
Compatibility with APFC loads.	Yes		
Performance at full load, in normal mode with battery 100% charged.	> 95 %		
Performance at full load, in battery mode.	> 78 %	> 80 %	
Overload in line mode	> 110 % ±10 % Audible alarm and fault after 1 min > 120 % ±10 % Immediate fault		
Overload in battery mode.	> 110 % ±10 % Audible alarm and fault after 1 min > 120 % ±10 % Immediate fault		
Batteries (AGM sealed 3 - 5 years life).			
Element voltage.	6 V DC		
Capacity.	9 Ah	7 Ah	9 Ah
Number of batteries in device connected in series / group voltage.	2 / 12 V DC	4 / 24 V DC	
Low battery voltage.	11.7 V	22.2 V	
Blocking voltage for group end of backup.	10.5 V	20.5 V	
Internal battery charger.			
Group floating voltage.	13.65 V	27.5 V	
Maximum charge current.	1 A		
Recharge time.	4 hours to 90%		
Other functions.			
Cold start.	Yes		
Emergency power off (EPO).	Yes		
General.			
IEC input connectors.	IEC 60320 C14 10A		
IEC output connectors.	IEC 60320 C13		
Communication ports.	(RS232 - DB9).		
Connector for external EPO installation	Yes		
Slot for optional cards.	SNMP		
Monitoring software.	PowerMaster (free download).		
Audible noise at 1 m in battery mode.	< 40 dB		
Operating temperature.	0..+40°C		
Storage temperature with batteries.	-20..+50 °C		
Storage temperature without batteries.	-20..+70 °C		
Working altitude.	2,400 masl (power degradation up to 5,000 m)		
Relative humidity.	0..90 % non-condensing.		
Protection rating.	IP20		
Dimensions (mm) Depth x Width x Height.	216x433x44 (1 U)	485x433x44 (1 U)	
Weight (kg).	8.6	14.2	16.2
Safety.	EN IEC 60240-1		
Electromagnetic compatibility (EMC).	EN IEC 60240-2		

Models.	ADVANCE R		
Available power ratings (VA / W).	750VA / 450W	1000VA / 600W	1500VA / 900W
Marking.	CE		
Quality and environmental management.	ISO 9001 and ISO 140001 (certified by SGS)		

Tab. 14. ADVANCE R general technical specifications.

Models.	ADVANCE T				
Available power ratings (VA / W).	850VA / 595W	1000VA / 700W	1500VA / 1050W	2000VA / 1400W	3000VA / 2100W
Technology.	Line-interactive with sine-wave output.				
Input.					
Input type.	Single-phase.				
Number of cables.	3 cables - Phase R (L) + Neutral (N) and earth.				
Rated voltage.	220 / 230 / 240 V AC				
Input voltage range.	165..290 V AC				
Input frequency range.	50 / 60 Hz (auto-detectable).				
Cold start (from batteries).	Yes				
Inverter.					
Waveform.	Pure sine wave.				
Power factor.	0.7				
Rated voltage.	220 / 230 / 240 V AC, selectable				
Output voltage accuracy (battery mode).	±10%				
Total harmonic distortion (THDv), with linear load.	< 5 % linear load <10 % non-linear load				
Frequency.	50 / 60 Hz. With mains absent -backup mode- 50 / 60 ±1% Hz.				
Transfer time, line mode to battery mode (normal mode).	4 ms				
Compatibility with APFC loads.	Yes				
Performance at full load, in normal mode with battery 100% charged.	> 98 %				
Performance at full load, in battery mode.	> 80 %				
Overload in line mode	> 110 % ±10 % Audible alarm and fault after 1 min > 120 % ±10 % Immediate fault				
Overload in battery mode.	> 110 % ±10 % Audible alarm and fault after 1 min > 120 % ±10 % Immediate fault				
Batteries (AGM sealed 3 - 5 years life). Only devices other than B1					
Element voltage.	12 V DC				
Capacity.	7 Ah	7.2 Ah	9 Ah	9 Ah	9 Ah
Number of batteries in device connected in series / group voltage.	2 / 24 V DC		2 / 24 V DC		4 / 48 V DC
Number of accumulators in battery module connected in series x no. packs in parallel / group voltage.	2 x 2/24 V DC		2 x 2/24 V DC		3 x 4/48 V DC
Low battery voltage.	23 V		23 V		45 V
Blocking voltage for group end of backup.	20.5 V		20.5 V		40 V
Internal battery charger.					
Group floating voltage.	27.5 V		27.5 V		54.8 V
Maximum charge current.	1 A (Devices other than B1) / 10 A (B1 devices)				
Recharge time.	4 hours to 90%				
Other functions.					
Cold start.	Yes				
Emergency power off (EPO).	Yes				
General.					
IEC input connectors.	IEC 60320 C14 10A			IEC 60320 C20	
IEC output connectors.	IEC 60320 C13			IEC 60320 C3 + Terminals	
Communication ports.	(1 x RS232 -DB9- and 1 x USB, functionally mutually exclusive).				
Connector for external EPO installation	Yes				
Slot for optional cards.	SNMP				
Monitoring software.	PowerMaster (free download).				
Audible noise at 1 m in battery mode.	< 45 dB			< 50 dB	
Operating temperature.	0..+40°C				
Storage temperature with batteries.	-20..+50 °C				
Storage temperature without batteries.	-20..+70 °C				
Working altitude.	2,400 masl (power degradation up to 5,000 m)				

Models.		ADVANCE T				
Available power ratings (VA / W).		850VA / 595W	1000VA / 700W	1500VA / 1050W	2000VA / 1400W	3000VA / 2100W
Relative humidity.		0..90 % non-condensing.				
Protection rating.		IP20				
Dimensions (mm) Depth × Width × Height.	UPS modules.	327 x 140 x 191				416 x 196 x 342
	Optional battery module.	-	327 x 140 x 191			416 x 196 x 342
Weight (kg).	UPS modules.	11.8	13.5	14.4	14.4	27.6
	UPS modules (B1).	-	8.3	10.2	12.5	22.1
	Optional battery module.	-	10.2	10.2	10.2	31.5
Safety.		EN IEC 60240-1				
Electromagnetic compatibility (EMC).		EN IEC 60240-2				
Operation.		EN-IEC 62040-3				
Marking.		CE				
Quality system.		ISO 9001 and ISO 140001 (certified by SGS)				

Tab. 15. ADVANCE T general technical specifications.

9.2. GLOSSARY.

- **AC.-** Alternating current is electric current in which the magnitude and direction vary cyclically. The waveform of the most commonly used alternating current is that of a sine wave, since this achieves a more efficient transmission of energy. In certain applications, however, other periodic waveforms are used, such as triangular or square.
- **Bypass.-** Manual or automatic, this is the physical connection between the input of an electrical device and its output.
- **DC.-** Direct current is the continuous flow of electrons through a conductor between two points with different potential. Unlike AC, in DC, electrical loads always circulate in the same direction from the point of greatest potential to the lowest. Although DC is commonly identified as a continuous current (for example, that supplied by a battery), any current that always maintains the same polarity is continuous.
- **DSP.-** Digital signal processor. A DSP is a processor or microprocessor-based system that has a set of instructions, hardware and optimised software for applications that require numerical operations at very high speed. Because of this, it is especially useful for the processing and representation of analogue signals in real time: in a system that works in this way (real time) samples are usually received from an analogue/digital converter (ADC).
- **Power factor.-** The power factor, PF, of an AC circuit is defined as the ratio between active power, P, and apparent power, S, or as the cosine of the angle formed by the current and voltage factors, designated in this case as $\cos \varphi$, where φ is the value of the angle.
- **GND.-** This stands for GROUND or EARTH and, as the name indicates, refers to the potential of the surface of the Earth.
- **EMI filter.-** Filter capable of significantly reducing electromagnetic interference (EMI), which is the disturbance that occurs in a radio receiver or in any other electrical circuit caused by electromagnetic radiation coming from an external source. Electromagnetic interference is also known as radio frequency interference (RFI). This disturbance can interrupt, degrade or limit the performance of the circuit
- **IGBT.-** An insulated gate bipolar transistor is a semiconductor device that is generally used as a controlled switch in power electronics circuits. This device possesses the characteristics of the gate signals of field effect transistors with the capacity for high current and low saturation voltage of the bipolar transistor, combining an isolated FET gate for input and control and a bipolar transistor as a single switch in a single device. The IGBT's excitation circuit is similar to that of the MOSFET, while the conducting characteristics are similar to those of the BJT.
- **Interface.-** In electronics, telecommunications and hardware, an interface (electronics) is the port (physical circuit) through which signals are sent or received from one system or subsystem to another
- **kVA.-** A volt-ampere is the unit used for apparent power in electrical current. In DC, it is practically equal to real power but, in AC, it can differ from this depending on the power factor.
- **LCD.-** Liquid crystal display, a device invented by Jack Janning, who was an employee of NCR. It is an electrical system for data presentation formed by 2 transparent conductive layers and a special crystalline material in the middle (liquid crystal) which have the ability to orientate light as it passes through.
- **LED.-** Light-emitting diode, a semiconductor device (diode) that emits light that is almost monochromatic, that is to say, it has a very narrow spectrum when it is polarised directly and is penetrated by an electric current. The colour (wavelength) depends on the semiconductor material used in the construction of the diode, and can vary from ultraviolet, passing through the visible light spectrum, to infrared, the latter called IRED (infra-red emitting diode).
- **Circuit breaker.-** A circuit breaker is a device capable of interrupting the electrical current of a circuit when it exceeds certain maximum values.
- **On-line mode.-** A device is said to be on-line when it is connected to a system, is operative, and normally has its power supply connected.
- **Inverter.-** An inverter is a circuit used to convert DC into AC. The function of an inverter is to change a DC input voltage to a symmetrical AC output voltage, with the magnitude and frequency desired by the user or designer.
- **Rectifier.-** In electronics, a rectifier is the element or circuit that converts AC into DC. This is done by using rectifier diodes, whether solid state semiconductors, vacuum valves

or gaseous valves, such as those containing mercury vapour. Depending on the characteristics of the AC power that they use, they are classified as single-phase when they are powered by a mains phase or three-phase when they are powered by three phases. Depending on the type of rectification, they can be half wave when only one of the half cycles of the current is used or full wave when both half cycles are used.

- **Relay.-** A relay is an electromechanical device that functions as a switch controlled by an electrical circuit in which, by means of an electromagnet, a set of one or several contacts is activated to enable other independent electrical circuits to be opened or closed.
- **SCR.-** Silicon controlled rectifier, commonly known as a thyristor, a 4-layer semiconductor device that works as an almost ideal switch.
- **THD.-** Total harmonic distortion. Harmonic distortion occurs when the output signal of a system does not equal the signal that entered it. This lack of linearity affects the waveform because the device has introduced harmonics that were not in the input signal. Since they are harmonic, that is to say, multiples of the input signal, this distortion is not so dissonant and is less easy to detect.

SALICRU

Avda. de la Serra 100

08460 Palautordera

BARCELONA

Tel. +34 93 848 24 00

services@salicru.com

SALICRU.COM



The Technical Service and Support (T.S.S.) network, Commercial network and warranty information are available in website:

www.salicru.com

Product Range

Uninterruptible Power Supplies (UPS)

Lighting Flow Dimmer-Stabilisers

DC Power Systems

Static Inverters

Photovoltaic Inverters

Voltage stabilisers



@salicru_SA



www.linkedin.com/company/salicru

